





EN INSTANTANEOUS ELECTRIC WATER HEATER















GENERAL SAFETY INSTRUCTIONS

CAUTION !

1. This manual is an integral part of the product. Keep it with care with the appliance, and hand it on to the next user/owner in case of change of property.
2. Read the instructions and warning in this manual carefully, they contain important information regarding safe installation, use and maintenance.
3. The appliance must be installed and commissioned by a qualified technician in accordance with local legislation and health and safety regulations. All power circuits must be shut off before you open the terminal block.
4. DO NOT use the appliance for any other than its specified use. The manufacturer is not liable for damage resulting from improper or incorrect use or failure to observe the instructions given in this manual.
5. Incorrect installation can result in damage to property and injury to persons and animals; the manufacturer is not liable for the consequences.
6. DO NOT leave the packaging materials (staples, plastic bags, expanded polystyrene, etc.) within the reach of children - they can cause serious injury.
7. The appliance is not intended for use by persons under 8 years of age, with reduced physical, sensory or mental capacity, or lacking the requisite experience and familiarity, unless under supervision or following instruction in the safe use of the appliance and the hazards attendant on such use. DO NOT permit children to play with the appliance. User cleaning and maintenance may not be done by unsupervised children.
8. Any repairs, maintenance, plumbing and electrical hookup must be done by qualified technicians using original spare parts only. Failure to observe the above instructions can compromise the safety of the appliance and relieves the manufacturer of any liability for the consequences.
9. The hot water temperature is regulated by a thermostat which also acts as a safety device to prevent dangerous overheating.
10. The electrical hookup must be done as indicated in this manual.
11. If the appliance is equipped with a power cord, the latter may only be replaced by an authorised service centre or professional technician.
12. Make sure to drain the appliance when it is out of service or in an area subject to subzero temperatures.
13. Do not leave flammable materials in contact with or in the vicinity of the appliance.

Symbol	Meaning
	Failure to observe this warning can result in injury, which may even be fatal in certain circumstances
	Failure to observe this warning can result in damage or injury, even to property; plants and animals
	Observe the product's general and specific safety instructions.

GENERAL SAFETY STANDARDS

Ref.	Warning	Risk	Symbol
1.	Do not open the appliance or remove from its installation	Electrocution hazard due to the presence of live electrical equipment. Personal injury -overheated burns caused by components and wounds caused by sharp edges	
2.	Do not start or stop the appliance by inserting/pulling the power plug	Electrocution hazard due to damage to the power cord, its plug or the socket	
3.	Do not damage the power cord	Electrocution hazard due to bare live wires	
4.	Do not leave objects on the appliance	Personal injury due to objects falling off the appliance as a result of vibration	
		Damage to the appliance or other property due to objects falling off the appliance as a result of vibration	
5.	Do not climb onto the appliance	Personal injury due to falling off the appliance	
		Damage to the appliance or other property due to the appliance itself detaching from its mounting	
6.	Do not clean the appliance without having first switched it off, pulled its power plug or shut off its power switch	Electrocution hazard due to the presence of live electrical equipment	
7.	Install the appliance to a solid wall which is not subject to vibration	Danger of the appliance falling off the wall due to structural collapse, or noisy operation	
8.	Make the electrical hookup with cables of adequate cross-section	Danger of fire due to overheating of undersized electrical wires	
9.	Restore all safety and control functions after working on the appliance and check that they are operational before returning it to service	Damage or blocking of the appliance due to improper control	
10.	Drain all components containing hot water, using the bleed cocks, before handling them	Danger of burns	
11.	Descale the system as given in the products "safety sheet"; when doing so, ventilate the room, wear safety clothing, make sure not to mix products, and protect the appliance itself and any adjacent objects	Personal injury due to contact of the skin and eyes with acid, inhalation or ingestion of noxious chemicals	
		Damage to the appliance and adjacent objects due to corrosion by acid	
12.	Do not use insecticides, solvents or aggressive detergents to clean the appliance	Damage to plastic and painted parts and assemblies	

TECHNICAL CHARACTERISTICS

For the technical specifications, refer to the nameplate (the nameplate is located on the right side of the water heater).

Product Information	
Power (kW)	9.5
Voltage	220-240V
Phases	Mono
Installation	Hidden Installation
Constructions	Close Outlet
Model	Refer to name plate
Frequency	50/60hz
Amper	39,6
Water Protection	IP24
Pipe Connection	1/2" BSP
Minimu, Water Flow	2.1L/Min
Qelec (kWh)	2,191
max water pressure (bar)	8 bar
Load Profile	XS
Lwa (db)	15db
wh	39%
Rated Volume (lt)	400cc
Weight	2400 gr
Dimensions	304 mm x 178 mm x 98 mm

The power consumption data in the table and the other information given in the Product Data Sheet (Enclosure A to this manual) are defined in relation to EU Directives 812/2013 and 814/2013.

The products without the label and the data sheet for water heaters and solar devices, stipulated in regulation 812/2013, are not intended to be used in such assemblies.

Products equipped with a regulator knob have the thermostat positioned in the <ready to use setting indicated in the Data Sheet (Enclosure A), according to which the relevant energy class has been declared by the manufacturer.

The product should be connected only to a supply with the relevant system impedance no more than 0.237 ohm.

Restrictions to connection may be imposed by the supply authority on the use of equipment in the actual relevant system impedance at the interface point on the user's premise exceeds 0.237 ohm.

This appliance is conforming with the international electrical safety standards IEC 60335-1 and IEC 60335-2-35. When present, The CE marking of the appliances attests its conformity to the following EC Directives, of which it satisfies the essential requisites:

- LVD Low Voltage Directive: EN 60335-1, EN 60335-2-35, EN 60529, EN 62233, EN 50106.
- EMC Electro-Magnetic Compatibility: EN 55014-1, EN 55014-2, EN 61000-3-2, EN 61000-3-3, EN 61000-3-11 and EN 61000-3-12.
- ERP Energy related Products: Eu812, Eu814, EN50193-1-2013

INSTALLATION INSTRUCTIONS

The appliance must be installed and commissioned by a qualified technician in accordance with established regulations and local health and safety regulations..

1. Open the four screws located on the top and bottom of the device and remove the cover from base.
2. Fix the base horizontally against a wall or side of cabinet, **ground wire must be connected to the unit**, the inlet and outlet water pipes are on the down/bottom side of the unit. Use 4 mounting screws provided.

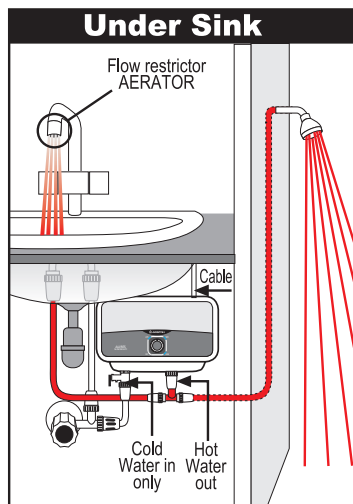
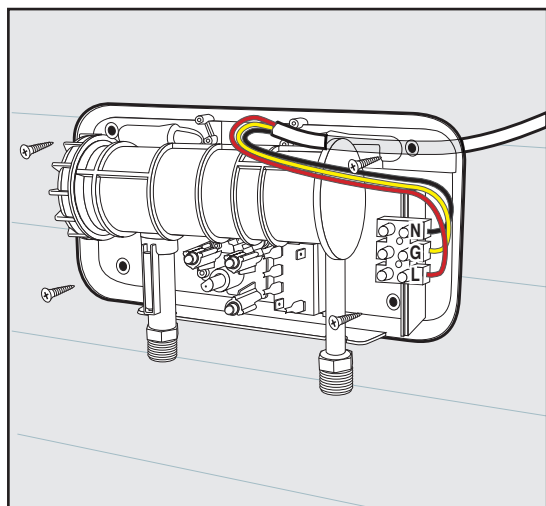

3. **Use the supplied water filter and PRD on the inlet water pipe line (see attached separate diagram Page 9).**
4. Connect the incoming water line (cold only) to the inlet water pipe on the bottom left side and the outgoing water line to the outlet water pipe on the bottom right side. Open the mains cock of water supply and check there is no water leakage from the unit.
5. Before performing any operations, disconnect the appliance from the electricity mains using the external switch then connect the power to cable to the appliance. The appliance must be earthed and the earth cable (shown with a letter in the drawing) is fixed to the terminal marked by the symbol \oplus .
6. Turn on the unit and check that it is operating as required.
7. Reconnect the cover to the base with 4 screws.
8. It is required that a Ground Fault Circuit Interrupter/Earth Leakage Circuit Breaker be incorporated in the circuit.
9. **Make sure to install in the right way the pressure relief valve (supplied with the product) before Inlet pipe.**
10. **It is required to install a flow control restrictor (AERATOR) at the sink or shower.**

11. WARNING: UNIT MUST BE PROPERLY GROUNDED

12. THIS HEATER MUST HAVE ITS OWN INDEPENDENT CIRCUIT USING A CORRECTLY RATED CIRCUIT BREAKER AND SUITABLE WIRE, SEE TABLE RECOMMENDED CABLE.

OPERATING INSTRUCTIONS

1. Your new Instant Water Heater is flow activated. Regulate the knob in one of the 3 setting power (Low, Med, High) the product will switch ON and turn on the hot water tap. the heating element will work and warm the water only when there is a flow of water through the appliance.. You will need to allow at least 2.1 liters per minute to flow through the unit in order to activate the Instant Heating System. Run water through the heater for a few minutes.
2. Be sure to every so often clean the spray head of sediment to assure a smooth water flow.
3. Be sure to every so often clean the incoming water filter.
4. Be sure to install your Instant Water Heater in a heated location. The appliance cannot be installed in areas where the temperature may drop critically and there may be a risk that ice may form.
5. The user can adjust the hot water temperature regulating the setting power on the unit. the user can choose till 4 setting poer position:
 - Power - Heating element is off
 - Low - Only the 1st Heating element switches on.
 - Med - Only the 2nd heating element switches on.
 - High - 1st and 2nd heating elements switch on, working together.

INSTALLATION REQUIREMENTS

- A. A separate electrical line is required.
- B. The device must be connected to a separate circuit breaker.
- C. The recommended electrical cable for feeding the device, see table I (next page).

INSTALLATION

Device with 220-240V from 7kW up to 12kW & 400-415V 3 Phase

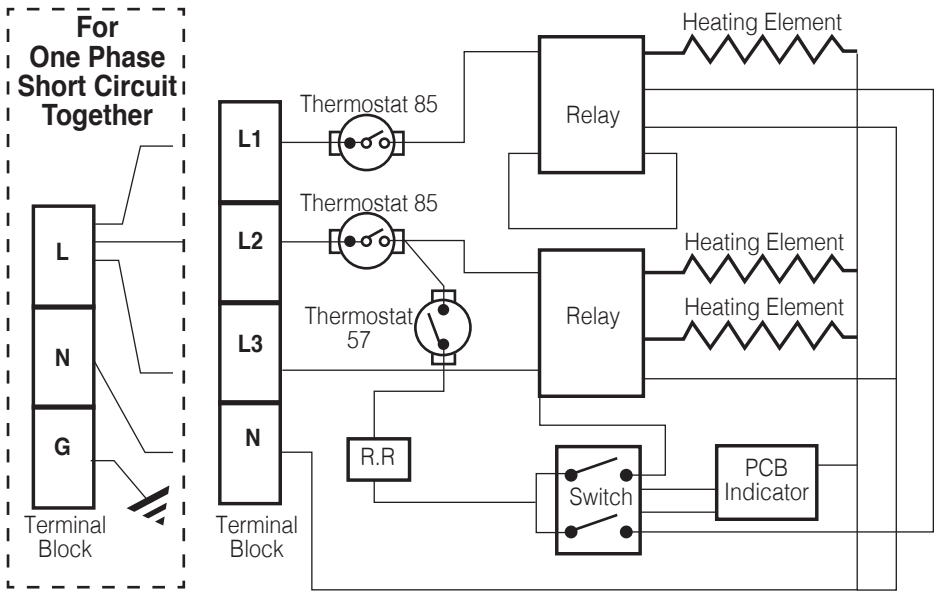

WARNING!

BEFORE BEGINNING ANY WORK ON THE ELECTRICAL INSTALLATION BE SURE THAT THE CIRCUIT BREAKER IS IN THE "OFF" POSITION TO AVOID DANGER OF ELECTRICAL SHOCK

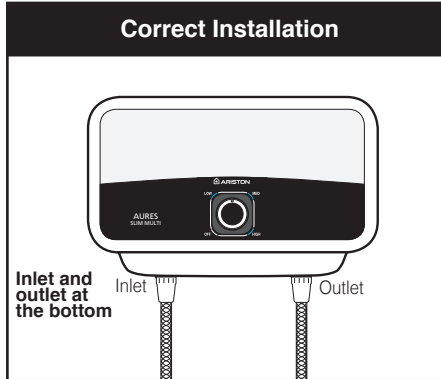
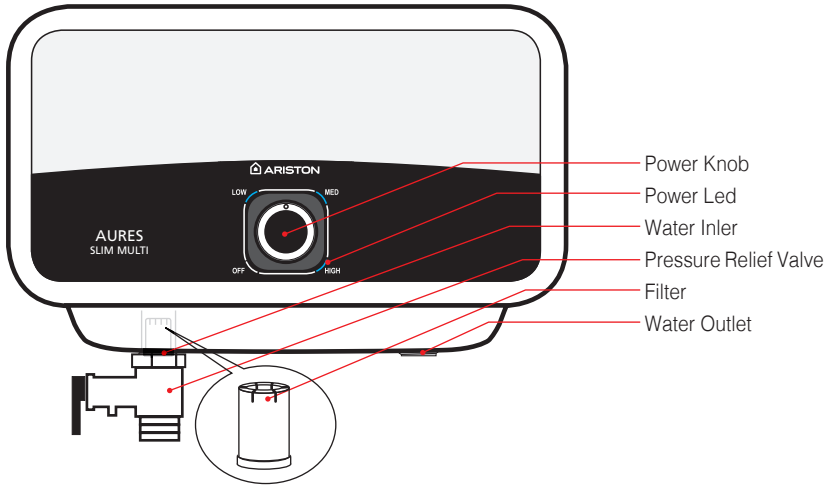

Table I: Recommended Cable

Model Name	Amper	220V	230V	240V	Heating Elements	Phases	Min Field wire mm ²
9.5 kW 240V	38.6	8.0kW	8.7kW	9.5kW	4.5+5	Mono	6

• Operating water pressure 0.5-8 bar (7-116 psi) • Water pressure operated flow switch
• Standard 1/2"Ø compression inlet connection • Top-left and right cable entry • Bottom-left water entry

UNIT DIMENSIONS: HEIGHT 178mm WIDTH 304mm DEPTH 98mm



Close cover Steps

A

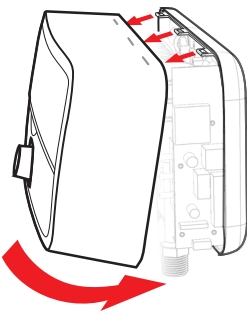

B

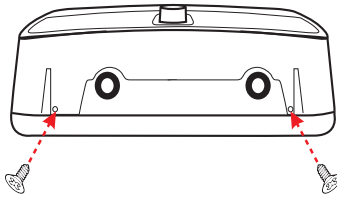

C

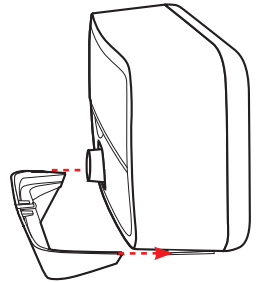

**This product conforms to Directive
WEEE 2012/19/EU.**



The symbol of the crossed waste paper basket on the appliance indicates that at the end of its working life the product should be disposed of separately from normal domestic household rubbish, it must be disposed of at a waste disposal center with dedicated facilities for electric and electronic appliances or returned to the retailer when a new replacement product is purchased.

The user is responsible for the disposal of the product at the end of its life at an appropriate waste disposal center.

The waste disposal center (which using special treatment and recycling processes effectively dismantles and disposes of the appliance) helps to protect the environment by recycling the material from which the product is made.

For further information about waste disposal systems visit your local waste disposal center or the retailer from which the product was purchased.

Product sizes

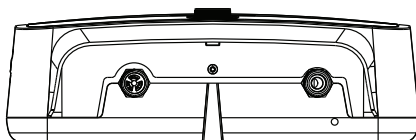
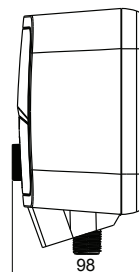
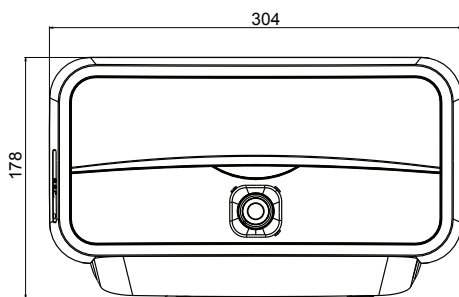

Troubleshooting

SYMPTOM	POSSIBLE CAUSE	SOLUTION
Water not hot enough	<p>Too much water flowing through the heater</p> <p>Reduction In the ambient temperature</p> <p>Water Pressure below of 100 kPa</p> <p>Electrical Malfunction</p>	<p>Reduce the flow rate of the water via the outlet tap.</p> <p>Switch to higher temperature setting.</p> <p>Check if the mains stop valve is fully open and that there are no other restriction in the supply line.</p> <p>Have the Heater unit check by a qualified electrician or contact your local authorised distributor.</p>
Water too hot	<p>Not enough Water flowing through the heater</p> <p>Increase in the ambient temperature</p>	<p>Increase the flow rate via the outlet tap</p> <p>Switch to lower temperature setting</p>
Heater switch Off during use	Interruption of mains electrical supply	Check incoming power supply, MCB, switches and supply cabling. Check earth leakage and reset ELSD
Water ceases to flow	<p>Blockage of spray head, twisted or blocked flexible shower hose.</p> <p>No water supply.</p>	<p>Clean or replace spray head, check for free passage of water through hose. Replace as necessary.</p> <p>Check water supply, stop valve Open? and no blockage.</p>
Water temperature varies from hot to cold during use	Water pressure has dropped below min. level.	Increase hot water supply,
No hot water despite fully open hot water faucet	<p>No electrical power</p> <p>The activation flow rate needed to turn on the heating element has not been reached.</p>	<p>Check the circuit breaker and check voltage at the wiring block.</p> <p>Clean filter screen</p> <ul style="list-style-type: none"> • Turn circuit breaker off • Open hot valve to release pressure from the unit. • Turn circuit breaker on.

Ariston Thermo S.p.A.,
Viale Aristide Merloni, 45
60044 Fabriano (AN)
Tel. (+39) 0732.6011
ariston.com



WE MAKE USE OF
RECYCLED PAPER